

Polyurethane Timing Belts

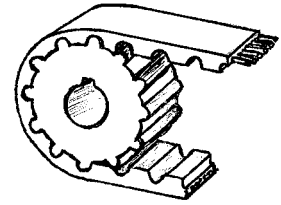

Polyurethane Timing Belts are offered in three standard metric pitches, 2.5mm, 5mm, and 10mm, and also standard imperial pitch, 1/5" (XL). In addition to the standard single sided belts, double sided belts with moulded teeth on both sides of the belt can be supplied (T5 and T10 only) for multishaft, serpentine drives and some conveyor applications. The metric belts are offered in two designs 'T' and 'AT' series both using steel tension cords encased in the polyurethane jacket with integral drive teeth. The method of manufacture ensures close control of pitch length, which combined with the inelastic properties of the steel tension member create a belt drive with high positional accuracy resulting in these belts being popular for instrument drives, robotics, and servo mechanisms. The imperial pitch belts use Kelvar tension members for increased strength and flexibility making them suited to higher power applications. The metric series belts can be also supplied with Kelvar tension member if required. Polyurethane has excellent resistance to mineral oils, greases and many slight acidic solutions, it is basically non marking and resistant to crumbling making it suitable for food and cigarette processing machines, and for paper handling in office equipment. Polyurethane belts can be used on applications with environmental temperature range -30°C, to 80°C, with belt speed up to 80 m/sec. In addition to the standard belt listed on page 39, open ended belt can be supplied for most constructions and widths, and fitted with welded attachments for conveying applications and positional rack drives, refer to page 45 for further details. The low inertia of the belts and aluminum pulleys plus accurate pitching make both the endless and open ended belt ideal for the high acceleration rates encountered in robotics. The high flexibility of the polyurethane belt enables crossed drives to be achieved (shafts at right angles), where reasonable length centres exist and narrow width belts are used. Both high shaft speeds and power capabilities can be achieved with the 'T' and 'AT' series of belts. The T2.5, T5, and AT5 belts are all able to run at up to 40,000 r.p.m with AT5 belts transmitting 15kW. The T10 and AT10 belts, can operate to 15,000 r.p.m with power capacity to 70kW, and higher powers of up to 200kW can be achieved with 20mm pitch AT 20 belts available to special order.

AT Series Polyurethane Timing Belts



Polyurethane belts are suitable for drives in a wide variety of machinery including Office machinery, Machine Tools, Pumps, Textile Machinery, Printing Machinery, Paper manufacturers, down to precision Camera drives and servo mechanisms. The 'AT' series of Polyurethane belts have increased tooth width and higher strength tension members than the 'T' Series. The increased tooth size with resultant increased stiffness improves meshing with pulley teeth and enables transmission of higher powers. Increased strength tension members improve pitch accuracy and also increase power capacity. Both improvements result in an increase of power transmission capacity of approx 50%. Quieter operation, as a result of improved tooth meshing, and reduced polygonal effect plus ability to use narrower section belts, is combined with improved positional accuracy of power transmission, with linear accuracy better than $\pm 0.1\text{mm/Metre}$ belt length.

Design limits for standard Polyurethane Timing Belts.

Belt Size Width x Pitch	Max. Allowable Belt Tension N.	Min. No. Teeth Drive Pulley	Min dia of Idler Pulley mm
6T2.5	65	10	15
10T5	330	10	30
16T5	570	10	30
25T5	930	10	30
16T10	1100	12	60
25T10	1800	12	60
32T10	2300	12	60
50T10	3800	12	60
10AT5	490	15	60
16AT5	840	15	60
25AT5	1100	15	60
25AT10	3500	15	120
32AT10	4750	15	120
50AT10	7750	15	120

Standard Belt Power Ratings

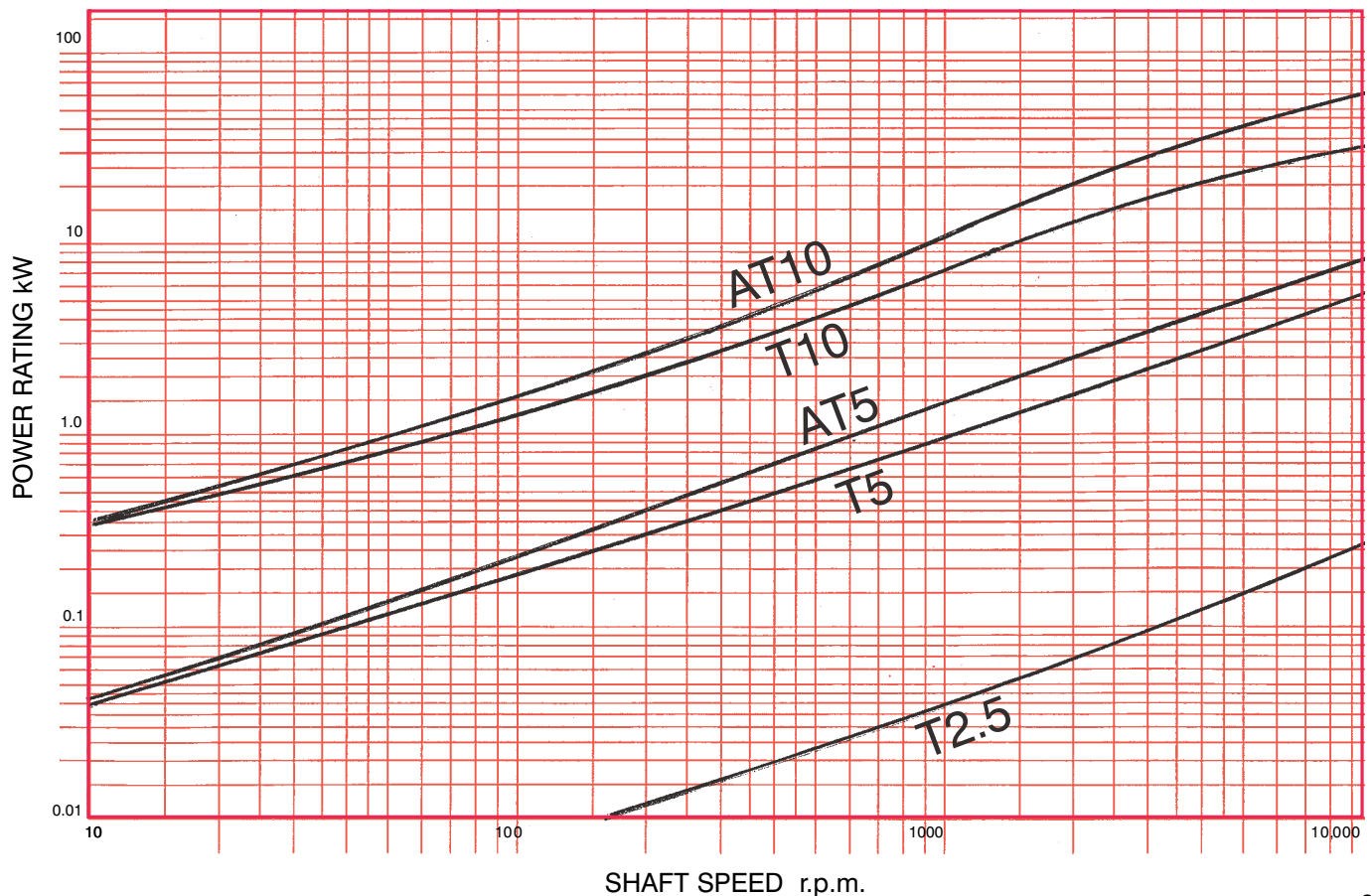

Tel +44 121 360 0155

Fax +44 121 325 1079

Email sales@crossmorse.com

Polyurethane Belt Drives Selection Procedure



The most important factor considered when selecting a Polyurethane "T" or "AT" series belt is the tooth shear strength. The calculation of Power capacity is based on the specific shear strength of each tooth in mesh relative to the belt width in cms. The maximum tooth shear strength F_s must not be exceeded. Values for tooth shear strength are shown in the table at foot of the page. The 'AT' series belts offer a higher tooth strength due to the larger tooth cross section. The high pitch accuracy of Polyurethane belts allows for up to 12 teeth to share the drive loads. Other factors which should be considered in belt selection are the number of teeth on the small pulley and diameters of tensioners/idlers pulleys. The drive design should also ensure that the maximum working load does not exceed maximum allowable tension of the members F_m .

In order to make a selection it is first necessary to compile together the following relevant design parameters

- Power to be transmitted P kW
- Speed of fastest shaft N_1 r.p.m.
- Drive ratio required, i - reduction or speed increase.
- Maximum pulley diameters which can be accommodated.
- Type of driver and driven equipment.
- Shaft diameters and centre distance A

Selection of Belt Pitch and Width.

- The size of Belt selected must always ensure maximum tooth shear and tensile strengths are not exceeded, and that pulley sizes meet their criteria. Under start-up conditions normal running torques can be exceeded by 2-2.5 times with electric motors, and this must be allowed for in the calculation. Peak loads caused by oscillating and torsional loads can be up to 1.7 times mean torque loads, and design factor f_1^* should consider this. Emergency braking systems may impose the maximum torque in the application. Speed increase drives impose heavier shock conditions, and a factor needs to be applied to cover these as below :-

$$\begin{aligned} i = 1 \text{ to } 1.5 & \quad f_2 = 1.1 \\ i = 1.5 \text{ to } 2.5 & \quad f_2 = 1.2 \\ i = 2.5 + & \quad f_2 = 1.3 \end{aligned}$$

* Values for f_1 can be found on page 4, Table 1.

The total design factor $f_d = f_1 + f_2$ or start-up overload factor f_s which ever is highest

The design Power $P_d = P \times f_d$ or f_s

Using graph on page opposite select suitable belt size to transmit the design power at the shaft speed N_1 r.p.m.

- Select number of teeth in pulleys, by consideration of the restraints of maximum pulley diameter and shaft diameters. The minimum pulley pitch diameter should be at least twice shaft diameter. The minimum number of teeth on the pulleys is also constrained by the belt design, reference belt characteristics table opposite page.

The actual pulley diameters can be obtained by referring to pulley dimension tables on pages 40-43 or by using formula.

$$\text{Pitch dia pulley } dp = \frac{Z \cdot p}{\Pi} \text{ mm}$$

The number of teeth in small and large pulleys can be determined from the drive reduction ratio i .

$$i = \frac{Z_2}{Z_1}$$

- Determine the number of teeth in mesh on small pulley Z_m from formula

$$Z_m = \frac{Z_1}{2\Pi} \left(\Pi - \sin^{-1} \left[\frac{Z_2 - Z_1}{\Pi \cdot A} \right] \right)$$

- Determine belt tension from drive Power P_d or drive torque M_d

$$F_T = \frac{1000 \cdot P_d}{Z_1 \cdot N_1 \cdot p} \quad \text{from power input}$$

$$\text{or } F_T = \frac{2000 \cdot T_d}{dp} \quad \text{from torque input}$$

- Determine belt width by consideration of belt tooth shear strength

$$\text{belt width } b = \frac{F_T}{F_s \cdot Z_m} \quad \text{cm}$$

Select the next largest standard width for belt.

If result from below formula for belt width gives impractical result rework selection sequence with next sizes of belt to obtain revised width.

- Final check belt tension maximum F_m is not exceeded i.e.

$$F_m \geq F_T$$

- To determine belt length refer to paragraph 5 on page 3.

Terms and Definitions :-

A	= centre distance pulley shafts	mm
b	= belt width	cm
d	= bore of pulley	mm
dp	= pitch diameter of pulley	mm
fd	= design factor	
fs	= starting overload factor	
F_m	= max. working tension in belt	N
F_s	= tooth shear resistance (see table below)	N/cm
F_T	= total linear force on belt	N
i	= drive ratio	
L	= belt Length	mm
N_1	= shaft speed - high speed shaft	r.p.m.
N_2	= shaft speed - low speed shaft	r.p.m.
P	= motor power	k.w
P_d	= design power	k.w
P	= belt pitch	mm
Z_1	= no teeth on small pulley	
Z_2	= no teeth on large pulley	
Z_m	= no teeth in mesh in small pulley	

Pulley Speed N r.p.m	Value for Teeth Shear Resistance F_s N/cm				
	T2.5	T5	T10	AT5	AT10
0	9.03	24.00	50.50	35.3	73.5
20	8.72	23.38	49.00	34.9	72.4
40	8.48	22.86	47.70	34.5	71.4
60	8.28	22.41	46.60	34.1	70.5
80	8.10	22.01	45.70	33.8	69.6
100	7.95	21.65	44.80	33.5	68.7
200	7.39	20.28	41.40	32.0	65.0
300	7.01	19.30	39.10	30.9	62.1
400	6.71	18.55	37.20	29.8	59.5
500	6.48	17.93	35.70	29.0	57.4
600	6.28	17.41	34.40	28.2	55.5
700	6.11	16.96	33.30	27.5	53.7
800	5.97	16.56	32.40	26.8	52.2
900	5.83	16.20	31.50	26.3	50.8
1000	5.71	15.88	30.70	25.7	49.5
1100	5.61	15.58	30.00	25.2	48.3
1200	5.51	15.31	29.30	24.8	47.2
1300	5.41	15.06	28.70	24.3	46.2
1400	5.33	14.83	28.20	23.9	45.2
1500	5.25	14.61	27.60	23.5	44.3
1600	5.17	14.40	27.10	23.2	43.4
1700	5.10	14.21	26.70	22.8	42.6
1800	5.04	14.03	26.20	22.5	41.8
1900	4.97	13.85	25.80	22.2	41.0
2000	4.91	13.69	25.40	21.9	40.3
2200	4.80	13.38	24.60	21.3	39.0
2400	4.70	13.10	23.90	20.8	37.8
2600	4.60	12.84	23.30	20.3	36.6
2800	4.51	12.59	22.70	19.8	35.5
3000	4.43	12.37	22.20	19.4	34.5
3200	4.36	12.16	21.70	19.0	33.6
3400	4.28	11.96	21.20	18.6	32.7
3600	4.22	11.77	20.70	18.3	31.9
3800	4.15	11.59	20.30	17.9	31.1
4000	4.09	11.42	19.86	17.6	30.3
4500	3.95	11.03	18.91	16.9	28.5
5000	3.82	10.68	18.06	16.2	26.9
5500	3.70	10.36	17.28	15.6	25.5
6000	3.60	10.07	16.58	15.0	24.2
6500	3.51	9.81	15.93	14.5	23.0
7000	3.42	9.56	15.33	14.0	21.8
7500	3.33	9.33	14.76	13.5	20.8
8000	3.26	9.11	14.24	13.1	19.8
9000	3.11	8.72	13.28	12.3	17.9
10000	2.99	8.37	12.42	11.6	16.3
12000	2.77	-	-	-	-
15000	2.50	-	-	-	-
18000	2.28	-	-	-	-
20000	2.15	-	-	-	-

Tel +44 121 360 0155

Fax +44 121 325 1079

Email sales@crossmorse.com

Standard Stock Polyurethane Belts



Standard belts are available in a number of stock widths as indicated below. For metric belts an individual belt reference number is obtained by prefixing the catalogue reference shown in tables, by its width in mm. For example a 280mm long belt of T5 construction with 12mm width has reference:

12T5-280
belt width - construction - length

For imperial pitch belts, the references are as rubber belts but prefixed 'U', e.g. U150XL037. Other pitches, belt lengths and widths can supplied to order. Contact Cross & Morse for further information.

2.5mm Pitch Belts - Ref. T2.5

Cat. Ref.	Length mm	No. Teeth
T2.5-120	120.0	48
T2.5-145	145.0	58
T2.5-160	160.0	64
T2.5-177	177.5	71
T2.5-180	180.0	72
T2.5-182	182.5	73
T2.5-200	200.0	80
T2.5-230	230.0	92
T2.5-245	245.0	98
T2.5-265	265.0	106
T2.5-285	285.0	114
T2.5-290	290.0	116
T2.5-305	305.0	122
T2.5-317	317.5	127
T2.5-330	330.0	132
T2.5-380	380.0	152
T2.5-420	420.0	168
T2.5-480	480.0	192
T2.5-500	500.0	200
T2.5-540	540.0	216
T2.5-600	600.0	240
T2.5-620	620.0	248
T2.5-650	650.0	260
T2.5-680	680.0	272
T2.5-700	700.0	280
T2.5-780	780.0	312
T2.5-880	880.0	352
T2.5-915	915.0	366
T2.5-950	950.0	380
T2.5-1185	1185.0	474

1/5" Pitch Belts - Ref. U-XL

Cat. Ref.	Length mm	No. Teeth
U60-XL	152.4	30
U70-XL	177.8	35
U80-XL	203.2	40
U90-XL	228.6	45
U100-XL	254.0	50
U110-XL	279.4	55
U120-XL	304.8	60
U130-XL	330.2	65
U140-XL	355.6	70
U150-XL	381.0	75
U160-XL	406.4	80
U170-XL	431.8	85
U180-XL	457.2	90
U190-XL	482.6	95
U200-XL	508.0	100
U210-XL	533.4	105
U220-XL	558.8	110
U230-XL	584.2	115
U240-XL	609.6	120
U250-XL	635.0	125
U260-XL	660.4	130

U-XL Belt Widths and Weights

Width Ref.	Belt Width	Weight gms/m
25	6.3	14
37	9.5	21
50	12.7	28

Open ended and long length fabricated belts are also available. Refer to page 44 for further details.

5mm Pitch Belts - Ref. T5

Cat. Ref.	Length mm	No. Teeth
T5-120	120	24
T5-150	150	30
T5-165	165	33
T5-180	180	36
T5-185	185	37
T5-200	200	40
T5-210	210	42
T5-215	215	43
T5-220	220	44
T5-225	225	45
T5-245	245	49
T5-250	250	50
T5-255	255	51
T5-260	260	52
T5-270	270	54
T5-275	275	55
T5-280	280	56
T5-295	295	59
T5-305	305	61
T5-330	330	66
T5-340	340	68
T5-350	350	70
T5-355	355	71
T5-365	365	73
T5-390	390	78
T5-400	400	80
T5-410*	410	82
T5-420	420	84
T5-425	425	85
T5-440	440	88
T5-445	445	89
T5-450	450	90
T5-455	455	91
T5-460*	460	92
T5-475	475	95
T5-480	480	96
T5-500	500	100
T5-510	510	102
T5-515	515	103
T5-525	525	105
T5-545	545	109
T5-550	550	110
T5-560	560	112
T5-575	575	115
T5-590*	590	118
T5-610	610	122
T5-620*	620	124
T5-630	630	126
T5-640	640	128
T5-650	650	130
T5-660	660	132
T5-675	675	135
T5-690	690	138
T5-700	700	140
T5-720	720	144
T5-725	725	145
T5-750*	750	150
T5-765	765	153
T5-780	780	156
T5-815*	815	163
T5-830	830	166
T5-840	840	168
T5-850	850	175
T5-860*	860	172
T5-885	885	177
T5-900	900	180
T5-940*	940	188
T5-990	990	198
T5-1075	1075	215
T5-1100*	1100	220
T5-1160	1160	232
T5-1200	1200	240
T5-1215	1215	243
T5-1275	1275	255
T5-1280	1280	256
T5-1315	1315	263
T5-1355	1355	271
T5-1380	1380	276
T5-1470	1470	294
T5-1500	1500	300
T5-1580	1580	316
T5-1955	1955	391

Belt Widths and Weights T & AT Series

Belt Type	Belt Width mm										
	4	6	8	10	12	16	20	25	32	50	75
T2.5	6	9	12	15	18						
T5		15	19	24	29	38	48	60			
T10				48	58	77	96	120	154	240	360
AT5		21	27	34	41	54	68	85			
AT10				63	76	101	126	158	202	315	473

Figures in Belt Width column for respective type of belt are weight gms/metre length. Unshaded weights are Standard Stock width belts, shaded are to order only.

5mm Pitch Belts - Ref. AT5

Cat. Ref.	Length mm	No. Teeth
AT5-225	225	45
AT5-255	255	51
AT5-275	275	55
AT5-280	280	56
AT5-300	300	60
AT5-330	330	66
AT5-340	340	68
AT5-375	375	75
AT5-390	390	78
AT5-420	420	84
AT5-450	450	90
AT5-455	455	91
AT5-480	480	96
AT5-500	500	100
AT5-525	525	105
AT5-545	545	109
AT5-600	600	120
AT5-610	610	122
AT5-630	630	126
AT5-660	660	132
AT5-670	670	134
AT5-710	710	142
AT5-720	720	144
AT5-750	750	150
AT5-780	780	156
AT5-825	825	165
AT5-860	860	172
AT5-975	975	195
AT5-1050	1050	210
AT5-1125	1125	225
AT5-1500	1500	300
AT5-2000	2000	400

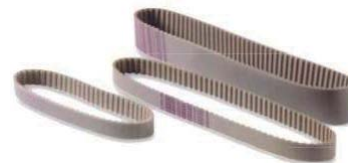

10mm Pitch Belts - Ref. T10

Cat. Ref.	Length mm	No. Teeth
T10-260*	260	26
T10-340	340	34
T10-370	370	37
T10-390	390	38
T10-400	400	40
T10-410	410	41
T10-440	440	44
T10-450	450	45
T10-480	480	48
T10-500	500	50
T10-530*	530	53
T10-550	550	55
T10-560	560	56
T10-600	600	60
T10-610	610	61
T10-630*	630	63
T10-650	650	65
T10-660*	660	66
T10-680	680	68
T10-690	690	69
T10-700	700	70
T10-720*	720	72
T10-730	730	73
T10-750	750	75
T10-780	780	78
T10-800	800	80
T10-810	810	81
T10-840*	840	84
T10-850	850	85
T10-880	880	88
T10-890	890	89
T10-900	900	90
T10-910	910	91
T10-920*	920	92
T10-950	950	95
T10-960	960	96
T10-970	970	97
T10-980*	980	98
T10-1010	1010	101
T10-1080	1080	108
T10-1110	1110	111
T10-1140	1140	114
T10-1150	1150	115
T10-1200	1200	120
T10-1210*	1210	121
T10-1240*	1240	124
T10-1250*	1250	125
T10-1300	1300	130
T10-1320*	1320	132
T10-1350*	1350	135
T10-1390	1390	139
T10-1400	1400	140
T10-1420*	1420	142
T10-1440	1440	144
T10-1450	1450	145
T10-1460	1460	146
T10-1500	1500	150
T10-1560	1560	156
T10-1610*	1610	161
T10-1700	1700	170
T10-1750	1750	175
T10-1780	1780	178
T10-1880*	1880	188
T10-1960	1960	196
T10-2250	2250	225

*These belt sizes are also available in Double Sided construction suffix 'DD' to Cat. No.

Tel +44 121 360 0155 Fax +44 121 325 1079 Email sales@crossmorse.com

Pulleys for Metric Polyurethane T2.5 and T5 Belts



Catalogue No.	No. Teeth Z	Pulley Type	Pitch Circle Diameter dp	Min. Bore d	Max Bore d	Outside Diameter do	Flange Diameter A	Pulley Width F	Bore Length L	Hub Diameter M	Approx. Weight kg
2.5mm Pitch Pulleys for 6mm Wide Belt Ref. 6T2.5-											
6 T2.5-12	12	0F	9.55	4	4.5	9.0	13.0	9	16	13	.003
6 T2.5-14	14	0F	11.14	4	6	10.6	15.0	9	16	15	.004
6 T2.5-15	15	0F	11.94	4	6	11.4	15.0	9	16	15	.005
6 T2.5-16	16	0F	12.73	4	7	12.2	16.0	9	16	16	.005
6 T2.5-18	18	1F	14.32	4	6.5	13.8	17.5	10	16	10	.006
6 T2.5-19	19	1F	15.12	4	6.5	14.6	18.0	10	16	10	.007
6 T2.5-20	20	1F	15.92	4	7	15.4	20.0	10	16	11	.008
6 T2.5-22	22	1F	17.51	4	7	17.0	23.0	10	16	11	.010
6 T2.5-24	24	1F	19.10	4	8	18.5	23.0	10	16	12	.012
6 T2.5-25	25	1F	19.89	4	8.5	19.3	23.0	10	16	13	.013
6 T2.5-26	26	1F	20.69	4	9	20.1	25.0	10	16	14	.014
6 T2.5-28	28	1F	22.28	4	9	21.7	25.0	10	16	14	.016
6 T2.5-30	30	1F	23.87	6	10	23.3	28.0	10	16	16	.018
6 T2.5-32	32	1F	25.46	6	10	24.9	32.0	10	16	16	.020
6 T2.5-36	36	1F	28.65	6	13	28.1	36.0	10	16	20	.026
6 T2.5-40	40	1F	31.83	6	14	31.3	38.0	10	16	22	.032
6 T2.5-44	44	1F	35.01	6	15	34.5	42.0	10	16	24	.040
6 T2.5-48	48	1	38.20	6	17	37.7	-	10	16	26	.048
6 T2.5-60	60	1	47.75	8	22	47.2	-	10	16	34	.073
5mm Pitch Pulleys for 10mm Wide Belt Ref. 10T5-											
10 T5-10	10	1F	15.92	4	5	15.0	19.5	15	21	8	.012
10 T5-12	12	1F	19.10	4	7	18.2	23.0	15	21	11	.016
10 T5-14	14	1F	22.28	4	8	21.4	25.0	15	21	13	.019
10 T5-15	15	1F	23.87	6	10	23.0	28.0	15	21	16	.021
10 T5-16	16	1F	25.46	6	11	24.6	32.0	15	21	18	.025
10 T5-18	18	1F	28.65	6	13	27.8	32.0	15	21	20	.031
10 T5-19	19	1F	30.24	6	14	29.4	36.0	15	21	22	.036
10 T5-20	20	1F	31.83	6	15	31.0	36.0	15	21	23	.038
10 T5-22	22	1F	35.01	6	15	34.1	38.0	15	21	24	.046
10 T5-24	24	1F	38.20	6	17	37.4	42.0	15	21	26	.054
10 T5-25	25	1F	39.79	6	17	38.9	44.0	15	21	26	.058
10 T5-26	26	1F	41.38	6	17	40.6	44.0	15	21	26	.062
10 T5-27	27	1F	42.97	8	19	42.2	48.0	15	21	30	.064
10 T5-28	28	1F	44.56	8	20	43.7	48.0	15	21	32	.071
10 T5-30	30	1F	47.75	8	22	46.9	51.0	15	21	34	.075
10 T5-32	32	1F	50.93	8	24	50.1	54.0	15	21	38	.088
10 T5-36	36	1F	57.30	8	24	56.4	64.0	15	21	38	.114
10 T5-40	40	1F	63.66	8	26	62.8	66.5	15	21	40	.138
10 T5-42	42	1F	66.84	8	26	66.0	70.0	15	21	40	.153
10 T5-44	44	1	70.03	8	29	69.2	-	15	21	45	.170
10 T5-48	48	1	76.39	8	32	75.5	-	15	21	50	.200
10 T5-60	60	1	95.49	8	42	94.6	-	15	21	65	.308
5mm Pitch Pulleys for 16mm Wide Belt Ref. 16T5-											
16 T5-10	10	1F	15.92	4	5	15.0	19.5	21	27	8	.016
16 T5-12	12	1F	19.10	4	7	18.2	23.0	21	27	11	.022
16 T5-14	14	1F	22.28	4	8	21.4	25.0	21	27	13	.027
16 T5-15	15	1F	23.87	6	10	23.0	28.0	21	27	16	.030
16 T5-16	16	1F	25.46	6	11	24.6	32.0	21	27	18	.036
16 T5-18	18	1F	28.65	6	13	27.8	32.0	21	27	20	.044
16 T5-19	19	1F	30.24	6	14	29.4	36.0	21	27	22	.050
16 T5-20	20	1F	31.83	6	15	31.0	36.0	21	27	23	.054
16 T5-22	22	1F	35.01	6	15	34.1	38.0	21	27	24	.055
16 T5-24	24	1F	38.20	6	17	37.4	42.0	21	27	26	.077
16 T5-25	25	1F	39.79	6	17	38.9	44.0	21	27	26	.082
16 T5-26	26	1F	41.38	6	17	40.6	44.0	21	27	26	.086
16 T5-27	27	1F	42.97	8	19	42.2	48.0	21	27	30	.092
16 T5-28	28	1F	44.56	8	20	43.7	48.0	21	27	32	.094
16 T5-30	30	1F	47.75	8	22	46.9	51.0	21	27	34	.106
16 T5-32	32	1F	50.93	8	24	50.1	54.0	21	27	38	.124
16 T5-36	36	1F	57.30	8	24	56.4	64.0	21	27	38	.160
16 T5-40	40	1F	63.66	8	26	62.8	66.5	21	27	40	.195
16 T5-42	42	1F	66.84	8	26	66.0	70.0	21	27	40	.206
16 T5-44	44	1	70.03	8	29	69.2	-	21	27	45	.230
16 T5-48	48	1	76.39	8	32	75.5	-	21	27	50	.282
16 T5-60	60	1	95.49	8	42	94.6	-	21	27	65	.432
5mm Pitch Pulleys for 25mm Wide Belt Ref. 25T5-											
25 T5-10	10	1F	15.92	4	5	15.0	19.5	30	36	8	.025
25 T5-12	12	1F	19.10	4	7	18.2	23.0	30	36	11	.032
25 T5-14	14	1F	22.28	4	8	21.4	25.0	30	36	13	.038
25 T5-15	15	1F	23.87	6	10	23.0	28.0	30	36	16	.042
25 T5-16	16	1F	25.46	6	11	24.6	32.0	30	36	18	.052
25 T5-18	18	1F	28.65	6	13	27.8	32.0	30	36	20	.063
25 T5-19	19	1F	30.24	6	14	29.4	36.0	30	36	22	.072
25 T5-20	20	1F	31.83	6	15	31.0	36.0	30	36	23	.078
25 T5-22	22	1F	35.01	6	15	34.1	38.0	30	36	24	.082
25 T5-24	24	1F	38.20	8	17	37.4	42.0	30	36	26	.110
25 T5-25	25	1F	39.79	8	17	38.9	44.0	30	36	26	.117
25 T5-26	26	1F	41.38	8	17	40.6	44.0	30	36	26	.121
25 T5-27	27	1F	42.97	8	19	42.2	48.0	30	36	30	.123
25 T5-28	28	1F	44.56	8	20	43.7	48.0	30	36	32	.127
25 T5-30	30	1F	47.75	8	22	46.9	51.0	30	36	34	.152
25 T5-32	32	1F	50.93	8	24	50.1	54.0	30	36	38	.177
25 T5-36	36	1F	57.30	8	24	56.4	64.0	30	36	38	.232
25 T5-40	40	1F	63.66	8	26	62.8	66.5	30	36	40	.278
25 T5-42	42	1F	66.84	8	26	66.0	70.0	30	36	40	.296
25 T5-44	44	1	70.03	8	29	69.2	-	30	36	45	.327
25 T5-48	48	1	76.39	8	32	75.5	-	30	36	50	.402
25 T5-60	60	1	95.49	8	42	94.6	-	30	36	65	.617

Pulley Types

The Pulley types referred to in tables are as drawings below. Suffix 'F' indicates pulley has flanges. Std. Pulleys can be reworked to customers bore and keywaying requirement.

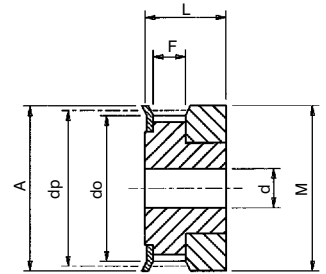

Type 0F

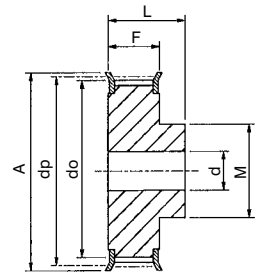

Type 1F

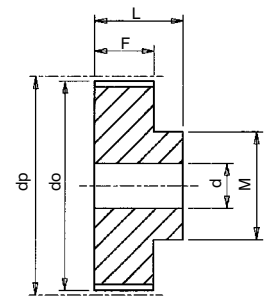

Type 1

All pulleys machined from aluminium for low weight and inertia, and fitted as indicated with steel flanges. All dimensions in mm

Tel +44 121 360 0155

Fax +44 121 325 1079

Email sales@crossmorse.com

Pulleys for Metric Polyurethane T10 Belts



Pulley Types

The Pulley types referred to in tables are as drawings below. Suffix 'F' indicates pulley has flanges.

Std. Pulleys can be reworked to customers bore and keywaying requirements.

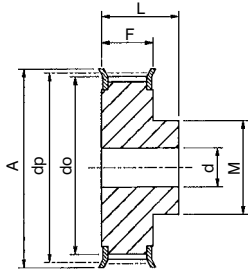

Type 1F

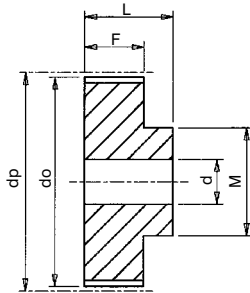

Type 1

All pulleys machined from aluminium for low weight and inertia, and fitted as indicated with steel flanges.
All dimensions in mm

Catalogue No.	No. Teeth Z	Pulley Type	Pitch Circle Dia. dp	Min. Bore d	Max. Bore d	Outside Diameter do	Flange Dia. A	Pulley Width F	Bore Length L	Hub Dia. M	Approx. Weight kg
10mm Pitch Pulleys for 16mm Wide Belt Ref. 16T10											
16 T10-12	12	1F	38.20	6	18	36.3	42	21	31	28	0.08
16 T10-14	14	1F	44.56	8	21	42.7	48	21	31	32	0.11
16 T10-15	15	1F	47.75	8	21	45.9	51	21	31	32	0.12
16 T10-16	16	1F	50.93	8	23	49.1	54	21	31	35	0.14
16 T10-18	18	1F	57.30	8	26	55.4	60	21	31	40	0.17
16 T10-19	19	1F	60.48	8	28	58.6	66	21	31	44	0.19
16 T10-20	20	1F	63.66	8	30	61.8	66	21	31	46	0.21
16 T10-22	22	1F	70.03	8	34	68.2	75	21	31	52	0.26
16 T10-24	24	1F	76.39	8	38	74.5	83	21	31	58	0.29
16 T10-25	25	1F	79.58	8	39	77.7	83	21	31	60	0.31
16 T10-26	26	1F	82.76	8	39	80.9	87	21	31	60	0.36
16 T10-27	27	1F	85.94	8	39	84.1	91	21	31	60	0.37
16 T10-28	28	1F	89.13	8	39	87.2	93	21	31	60	0.40
16 T10-30	30	1F	95.49	8	39	93.6	97	21	31	60	0.44
16 T10-32	32	1F	101.86	10	42	100.0	106	21	31	65	0.49
16 T10-36	36	1F	114.59	10	45	112.7	120	21	31	70	0.63
16 T10-40	40	1F	127.32	10	52	125.4	131	21	31	80	0.77
16 T10-44	44	1	140.06	10	57	138.2	-	21	31	88	1.00
16 T10-48	48	1	152.79	16	62	150.9	-	21	31	95	1.09
16 T10-60	60	1	190.99	16	72	189.1	-	21	31	110	1.70
10mm Pitch Pulleys for 25mm Wide Belt Ref. 25T10											
25 T10-12	12	1F	38.20	6	18	36.3	42	30	40	28	0.10
25 T10-14	14	1F	44.56	8	21	42.7	48	30	40	32	0.14
25 T10-15	15	1F	47.75	8	21	45.9	51	30	40	32	0.16
25 T10-16	16	1F	50.93	8	23	49.1	54	30	40	35	0.18
25 T10-18	18	1F	57.30	8	26	55.4	60	30	40	40	0.23
25 T10-19	19	1F	60.48	8	28	58.6	66	30	40	44	0.25
25 T10-20	20	1F	63.66	8	30	61.8	66	30	40	46	0.28
25 T10-22	22	1F	70.03	8	34	68.2	75	30	40	52	0.34
25 T10-24	24	1F	76.39	8	38	74.5	83	30	40	58	0.39
25 T10-25	25	1F	79.58	8	39	77.7	83	30	40	60	0.42
25 T10-26	26	1F	82.76	8	39	80.9	87	30	40	60	0.48
25 T10-27	27	1F	85.94	8	39	84.1	91	30	40	60	0.54
25 T10-28	28	1F	89.13	8	39	87.2	93	30	40	60	0.55
25 T10-30	30	1F	95.49	8	39	93.6	97	30	40	60	0.64
25 T10-32	32	1F	101.86	10	42	100.0	106	30	40	65	0.69
25 T10-36	36	1F	114.59	10	45	112.7	120	30	40	70	0.87
25 T10-40	40	1F	127.32	10	52	125.4	131	30	40	80	1.07
25 T10-44	44	1	140.06	10	57	138.2	-	30	40	88	1.35
25 T10-48	48	1	152.79	16	62	150.9	-	30	40	95	1.52
25 T10-60	60	1	190.99	16	72	189.1	-	30	40	110	2.34
10mm Pitch Pulleys for 32mm Wide Belt Ref. 32T10-											
32 T10-18	18	1F	57.30	10	26	55.4	60	37	47	40	0.26
32 T10-19	19	1F	60.48	10	28	58.6	66	37	47	44	0.28
32 T10-20	20	1F	63.66	12	30	61.8	66	37	47	46	0.32
32 T10-22	22	1F	70.03	12	34	68.2	75	37	47	52	0.40
32 T10-24	24	1F	76.39	12	38	74.5	83	37	47	58	0.48
32 T10-25	25	1F	79.58	12	39	77.7	83	37	47	60	0.53
32 T10-26	26	1F	82.76	12	39	80.9	87	37	47	60	0.57
32 T10-27	27	1F	85.94	12	39	84.1	91	37	47	60	0.60
32 T10-28	28	1F	89.13	12	39	87.2	93	37	47	60	0.64
32 T10-30	30	1F	95.49	12	39	93.6	97	37	47	60	0.74
32 T10-32	32	1F	101.86	12	42	100.0	106	37	47	65	0.85
32 T10-36	36	1F	114.59	16	45	112.7	120	37	47	70	1.07
32 T10-40	40	1F	127.32	16	52	125.4	131	37	47	80	1.32
32 T10-44	44	1	140.06	16	57	138.2	-	37	47	88	1.61
32 T10-48	48	1	152.79	16	62	150.9	-	37	47	95	1.93
32 T10-60	60	1	190.99	16	72	189.1	-	37	47	110	3.00
10mm Pitch Pulleys for 50mm Wide Belt Ref. 50T10											
50 T10-18	18	1F	57.30	10	26	55.4	60	56	66	40	0.43
50 T10-19	19	1F	60.48	10	28	58.6	66	56	66	44	0.47
50 T10-20	20	1F	63.66	12	30	61.8	66	56	66	46	0.52
50 T10-22	22	1F	70.03	12	34	68.2	75	56	66	52	0.57
50 T10-24	24	1F	76.39	12	38	74.5	83	56	66	58	0.74
50 T10-25	25	1F	79.58	12	39	77.7	83	56	66	60	0.77
50 T10-26	26	1F	82.76	12	39	80.9	87	56	66	60	0.82
50 T10-27	27	1F	85.94	12	39	84.1	91	56	66	60	0.91
50 T10-28	28	1F	89.13	12	39	87.2	93	56	66	60	0.96
50 T10-30	30	1F	95.49	12	39	93.6	97	56	66	60	1.17
50 T10-32	32	1F	101.86	12	42	100.0	106	56	66	65	1.30
50 T10-36	36	1F	114.59	16	45	112.7	120	56	66	70	1.64
50 T10-40	40	1F	127.32	16	52	125.4	131	56	66	80	2.00
50 T10-44	44	1	140.06	16	57	138.2	-	56	66	88	2.36
50 T10-48	48	1	152.79	16	62	150.9	-	56	66	95	2.83
50 T10-60	60	1	190.99	16	72	189.1	-	56	66	110	4.37

Pulley Installation

Correct and accurate installation of Timing Drives is essential. Pulley alignment and shaft parallelism is very important as misalignment of the drive will cause unequal loading across the belt width and edge wear of belt on flanges. Pulley alignment can be checked by placing a straight edge against the outside edge of the pulleys and adjusting so contact made evenly across both pulleys.

The shafts should be located within a rigid framework, as any distortion under load could result in a reduction of centre distance which will cause jumping of belt on pulley teeth. If idlers are used they must be locked firmly into position after correct belt tensioning. Refer to page 10 for additional information on drive installation.

Tel +44 121 360 0155

Fax +44 121 325 1079

Email sales@crossmorse.com

Pulleys for Metric Polyurethane AT 5 Belts



AT Series Timing Pulleys

Designed to complete the power Transmission package for the enhanced power 'AT' series belts, are the Cross pilot bore stock pulleys for AT5 and AT10 belt drives.

The 'AT' series belts provide increased power capacity in a Polyurethane belt by increasing the belt tooth size and also the tension members.

The increased tooth width of AT series belts increases both the strength and stiffness of the tooth improving meshing with the pulley's also the longer flat surface of the teeth enables better transmission of radial loads.

Higher strength tension members improve pitch accuracy along with increasing the tensile strength of the belt, which combined with the stronger teeth enables increase in power transmitted by approx 50% over the 'T' series belts.

The 'AT' belt design provides improved accuracy in linear drives, with reduced backlash when using standard pulleys. The longer tooth reduces polygon effect which combined with the opportunity to reduce belt width enables reduction in noise levels.

Cross offer AT5 and AT10 pulleys as standard, but can also manufacture to customers design including AT20.

Catalogue No.	No. Teeth Z	Pulley Type	Pitch Circle Diameter dp	Min. Bore d	Max Bore d	Outside Diameter do	Flange Diameter A	Pulley Width F	Bore Length L	Hub Diameter M	Approx. Weight kg
5mm Pitch Pulleys for 10mm Wide Belt Ref. 10AT 5											
10AT5-12	12	1F	19.10	4	7	18.2	23.0	15	21	11	.016
10AT5-14	14	1F	22.28	4	9	21.4	25.0	15	21	14	.019
10AT5-15	15	1F	23.87	6	10	23.0	28.0	15	21	16	.021
10AT5-16	16	1F	25.46	6	11	24.6	32.0	15	21	18	.025
10AT5-18	18	1F	28.65	6	13	27.8	32.0	15	21	20	.031
10AT5-19	19	1F	30.24	6	14	29.4	36.0	15	21	22	.036
10AT5-20	20	1F	31.83	6	15	31.0	36.0	15	21	23	.038
10AT5-22	22	1F	35.01	6	15	34.1	38.0	15	21	24	.046
10AT5-24	24	1F	38.20	6	17	37.4	42.0	15	21	26	.054
10AT5-25	25	1F	39.79	6	17	38.9	44.0	15	21	26	.058
10AT5-26	26	1F	41.38	6	17	40.6	44.0	15	21	26	.062
10AT5-27	27	1F	42.97	8	19	42.2	48.0	15	21	30	.064
10AT5-28	28	1F	44.56	8	20	43.7	48.0	15	21	32	.071
10AT5-30	30	1F	47.75	8	22	46.9	51.0	15	21	34	.075
10AT5-32	32	1F	50.93	8	23	50.1	54.0	15	21	36	.088
10AT5-36	36	1F	57.30	8	24	56.4	64.0	15	21	38	.114
10AT5-40	40	1F	63.66	8	26	62.8	66.5	15	21	40	.138
10AT5-42	42	1F	66.84	8	26	66.0	70.0	15	21	40	.153
10AT5-44	44	1	70.03	8	29	69.2	-	15	21	45	.170
10AT5-48	48	1	76.39	8	32	75.5	-	15	21	50	.200
10AT5-60	60	1	95.49	8	42	94.6	-	15	21	65	.308
5mm Pitch Pulleys for 16mm Wide Belt Ref. 16AT 5											
16AT5-12	12	1F	19.10	4	7	18.2	23.0	21	27	11	.022
16AT5-14	14	1F	22.28	4	9	21.4	25.0	21	27	14	.027
16AT5-15	15	1F	23.87	6	10	23.0	28.0	21	27	16	.030
16AT5-16	16	1F	25.46	6	11	24.6	32.0	21	27	18	.036
16AT5-18	18	1F	28.65	6	13	27.8	32.0	21	27	20	.044
16AT5-19	19	1F	30.24	6	14	29.4	36.0	21	27	22	.050
16AT5-20	20	1F	31.83	6	15	31.0	36.0	21	27	23	.054
16AT5-22	22	1F	35.01	6	15	34.1	38.0	21	27	24	.055
16AT5-24	24	1F	38.20	6	17	37.4	42.0	21	27	26	.077
16AT5-25	25	1F	39.79	6	17	38.9	44.0	21	27	26	.082
16AT5-26	26	1F	41.38	6	17	40.6	44.0	21	27	26	.086
16AT5-27	27	1F	42.97	8	19	42.2	48.0	21	27	30	.092
16AT5-28	28	1F	44.56	8	20	43.7	48.0	21	27	32	.094
16AT5-30	30	1F	47.75	8	22	46.9	51.0	21	27	34	.106
16AT5-32	32	1F	50.93	8	23	50.1	54.0	21	27	36	.124
16AT5-36	36	1F	57.30	8	24	56.4	64.0	21	27	38	.160
16AT5-40	40	1F	63.66	8	26	62.8	66.5	21	27	40	.195
16AT5-42	42	1F	66.84	8	26	66.0	70.0	21	27	40	.206
16AT5-44	44	1	70.03	8	29	69.2	-	21	27	45	.230
16AT5-48	48	1	76.39	8	32	75.5	-	21	27	50	.282
16AT5-60	60	1	95.49	8	42	94.6	-	21	27	65	.432
5mm Pitch Pulleys for 25mm Wide Belt Ref. 25AT 5											
25AT5-12	12	1F	19.10	4	7	18.2	23.0	30	36	11	.032
25AT5-14	14	1F	22.28	4	9	21.4	25.0	30	36	14	.038
25AT5-15	15	1F	23.87	6	10	23.0	28.0	30	36	16	.042
25AT5-16	16	1F	25.46	6	11	24.6	32.0	30	36	18	.052
25AT5-18	18	1F	28.65	6	13	27.8	32.0	30	36	20	.063
25AT5-19	19	1F	30.24	6	14	29.4	36.0	30	36	22	.072
25AT5-20	20	1F	31.83	6	15	31.0	36.0	30	36	23	.078
25AT5-22	22	1F	35.01	6	15	34.1	38.0	30	36	24	.082
25AT5-24	24	1F	38.20	8	17	37.4	42.0	30	36	26	.110
25AT5-25	25	1F	39.79	8	17	38.9	44.0	30	36	26	.117
25AT5-26	26	1F	41.38	8	17	40.6	44.0	30	36	26	.121
25AT5-27	27	1F	42.97	8	19	42.2	48.0	30	36	30	.123
25AT5-28	28	1F	44.56	8	20	43.7	48.0	30	36	32	.127
25AT5-30	30	1F	47.75	8	22	46.9	51.0	30	36	34	.152
25AT5-32	32	1F	50.93	8	23	50.1	54.0	30	36	36	.177
25AT5-36	36	1F	57.30	8	24	56.4	64.0	30	36	38	.232
25AT5-40	40	1F	63.66	8	26	62.8	66.5	30	36	40	.278
25AT5-42	42	1F	66.84	8	26	66.0	70.0	30	36	40	.296
25AT5-44	44	1	70.03	8	29	69.2	-	30	36	45	.327
25AT5-48	48	1	76.39	8	32	75.5	-	30	36	50	.402
25AT5-60	60	1	95.49	8	42	94.6	-	30	36	65	.617

Pulley Types

The Pulley types referred to in tables are as drawings below. Suffix 'F' indicates pulley has flanges.

Std. Pulleys can be reworked to customers bore and keywaying requirement.

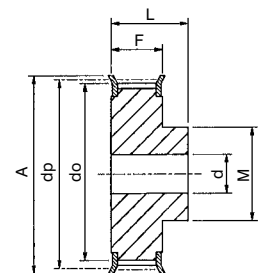

Type 1F

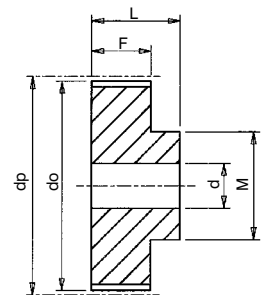

Type 1

All pulleys machined from aluminium for low weight and inertia, and fitted as indicated with steel flanges. All dimensions in mm

Tel +44 121 360 0155

Fax +44 121 325 1079

Email sales@crossmorse.com

Pulleys for Metric Polyurethane AT10 Belts



Pulley Types

The Pulley types referred to in tables are as drawings below. Suffix 'F' indicates pulley has flanges.

Std. Pulleys can be reworked to customers bore and keywaying requirements.

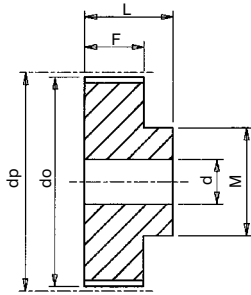

Type 1

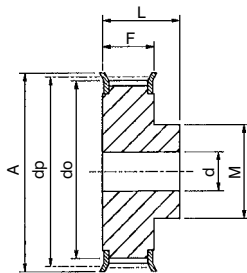

Type 1F

All pulleys machined from aluminium for low weight and inertia, and fitted as indicated with steel flanges. All dimensions in mm

Catalogue No.	No. Teeth Z	Pulley Type	Pitch Circle Dia. dp	Min. Bore d	Max. Bore d	Outside Diameter do	Flange Dia. A	Pulley Width F	Bore Length L	Hub Dia. M	Approx. Weight kg
10mm Pitch Pulleys for 16mm Wide Belt Ref. 16AT10											
16 AT10-15	15	1F	47.75	8	20	45.9	51	21	31	31	0.12
16 AT10-16	16	1F	50.93	8	23	49.1	54	21	31	35	0.14
16 AT10-18	18	1F	57.30	8	26	55.4	60	21	31	40	0.17
16 AT10-19	19	1F	60.48	8	28	58.6	66	21	31	44	0.19
16 AT10-20	20	1F	63.66	8	30	61.8	66	21	31	46	0.21
16 AT10-22	22	1F	70.03	8	34	68.2	75	21	31	52	0.26
16 AT10-24	24	1F	76.39	8	38	74.5	83	21	31	58	0.29
16 AT10-25	25	1F	79.58	8	39	77.7	83	21	31	60	0.31
16 AT10-26	26	1F	82.76	8	39	80.9	87	21	31	60	0.36
16 AT10-27	27	1F	85.94	8	39	84.1	91	21	31	60	0.37
16 AT10-28	28	1F	89.13	8	39	87.2	93	21	31	60	0.40
16 AT10-30	30	1F	95.49	8	39	93.6	97	21	31	60	0.44
16 AT10-32	32	1F	101.86	10	42	100.0	106	21	31	65	0.49
16 AT10-36	36	1F	114.59	10	45	112.7	120	21	31	70	0.63
16 AT10-40	40	1F	127.32	10	52	125.4	135	21	31	80	0.77
16 AT10-44	44	1	140.06	10	57	138.2	-	21	31	88	1.00
16 AT10-48	48	1	152.79	16	62	150.9	-	21	31	95	1.09
16 AT10-60	60	1	190.99	16	72	189.1	-	21	31	110	1.70
10mm Pitch Pulleys for 25mm Wide Belt Ref. 25AT10											
25 AT10-15	15	1F	47.75	8	21	45.9	51	30	40	32	0.16
25 AT10-16	16	1F	50.93	8	23	49.1	54	30	40	35	0.18
25 AT10-18	18	1F	57.30	8	26	55.4	60	30	40	40	0.23
25 AT10-19	19	1F	60.48	8	28	58.6	66	30	40	44	0.25
25 AT10-20	20	1F	63.66	8	30	61.8	66	30	40	46	0.28
25 AT10-22	22	1F	70.03	8	34	68.2	75	30	40	52	0.34
25 AT10-24	24	1F	76.39	8	38	74.5	83	30	40	58	0.39
25 AT10-25	25	1F	79.58	8	39	77.7	83	30	40	60	0.42
25 AT10-26	26	1F	82.76	8	39	80.9	87	30	40	60	0.48
25 AT10-27	27	1F	85.94	8	39	84.1	91	30	40	60	0.54
25 AT10-28	28	1F	89.13	8	39	87.2	93	30	40	60	0.55
25 AT10-30	30	1F	95.49	8	39	93.6	97	30	40	60	0.64
25 AT10-32	32	1F	101.86	10	42	100.0	106	30	40	65	0.69
25 AT10-36	36	1F	114.59	10	45	112.7	120	30	40	70	0.87
25 AT10-40	40	1F	127.32	10	52	125.4	135	30	40	80	1.07
25 AT10-44	44	1	140.06	10	57	138.2	-	30	40	88	1.35
25 AT10-48	48	1	152.79	16	62	150.9	-	30	40	95	1.52
25 AT10-60	60	1	190.99	16	72	189.1	-	30	40	110	2.34
10mm Pitch Pulleys for 32mm Wide Belt Ref. 32AT10-											
32 AT10-18	18	1F	57.30	10	26	55.4	60	37	47	40	0.26
32 AT10-19	19	1F	60.48	10	28	58.6	66	37	47	44	0.28
32 AT10-20	20	1F	63.66	12	30	61.8	66	37	47	46	0.32
32 AT10-22	22	1F	70.03	12	34	68.2	75	37	47	52	0.40
32 AT10-24	24	1F	76.39	12	38	74.5	83	37	47	58	0.48
32 AT10-25	25	1F	79.58	12	39	77.7	83	37	47	60	0.53
32 AT10-26	26	1F	82.76	12	39	80.9	87	37	47	60	0.57
32 AT10-27	27	1F	85.94	12	39	84.1	91	37	47	60	0.60
32 AT10-28	28	1F	89.13	12	39	87.2	93	37	47	60	0.64
32 AT10-30	30	1F	95.49	12	39	93.6	97	37	47	60	0.74
32 AT10-32	32	1F	101.86	12	42	100.0	106	37	47	65	0.85
32 AT10-36	36	1F	114.59	16	45	112.7	120	37	47	70	1.07
32 AT10-40	40	1F	127.32	16	52	125.4	135	37	47	80	1.32
32 AT10-44	44	1	140.06	16	57	138.2	-	37	47	88	1.61
32 AT10-48	48	1	152.79	16	62	150.9	-	37	47	95	1.93
32 AT10-60	60	1	190.99	16	72	189.1	-	37	47	110	3.00
10mm Pitch Pulleys for 50mm Wide Belt Ref. 50AT10											
50 AT10-18	18	1F	57.30	10	26	55.4	60	56	66	40	0.43
50 AT10-19	19	1F	60.48	10	28	58.6	66	56	66	44	0.47
50 AT10-20	20	1F	63.66	12	30	61.8	66	56	66	46	0.52
50 AT10-22	22	1F	70.03	12	34	68.2	75	56	66	52	0.57
50 AT10-24	24	1F	76.39	12	38	74.5	83	56	66	58	0.74
50 AT10-25	25	1F	79.58	12	39	77.7	83	56	66	60	0.77
50 AT10-26	26	1F	82.76	12	39	80.9	87	56	66	60	0.82
50 AT10-27	27	1F	85.94	12	39	84.1	91	56	66	60	0.91
50 AT10-28	28	1F	89.13	12	39	87.2	93	56	66	60	0.96
50 AT10-30	30	1F	95.49	12	39	93.6	97	56	66	60	1.17
50 AT10-32	32	1F	101.86	12	42	100.0	106	56	66	65	1.30
50 AT10-36	36	1F	114.59	16	45	112.7	120	56	66	70	1.64
50 AT10-40	40	1F	127.32	16	52	125.4	135	56	66	80	2.00
50 AT10-44	44	1	140.06	16	57	138.2	-	56	66	88	2.36
50 AT10-48	48	1	152.79	16	62	150.9	-	56	66	95	2.83
50 AT10-60	60	1	190.99	16	72	189.1	-	56	66	110	4.37

Pulley Installation

Correct and accurate installation of Timing Drives is essential. Pulley alignment and shaft parallelism is very important as misalignment of the drive will cause unequal loading across the belt width and edge wear of belt on flanges. Pulley alignment can be checked by placing a straight edge against the outside edge of the pulleys and adjusting so contact made evenly across both pulleys.

The shafts should be located within a rigid framework, as any distortion under load could result in a reduction of centre distance which will cause jumping of belt on pulley teeth. If idlers are used they must be locked firmly into position after correct belt tensioning.

Refer to page 10 for additional information on drive installation.

Tel +44 121 360 0155

Fax +44 121 325 1079

Email sales@crossmorse.com

Open Ended and Special Construction Polyurethane Timing Belts



Open ended belts are manufactured in a continuous process with the steel tension members running parallel to the edges. The belts are manufactured in standard 50 metre rolls, but longer lengths are available to request. The open ended belts are normally used for reciprocating linear motions such as robotics.

The open ended belts can also be used to produce long length endless belts which are produced using an automated, precision cut vee finger joint which is weld joined. The strength of the joint is by the polyurethane, but due to the large contact area loads up to 50% of the belt capacity can still be transmitted, whilst excellent flexibility and smooth running are retained. The joined belts are mainly used on Conveyor applications, and the addition of welded attachments and special backing materials extends application opportunities.

Standard Tooth Forms available

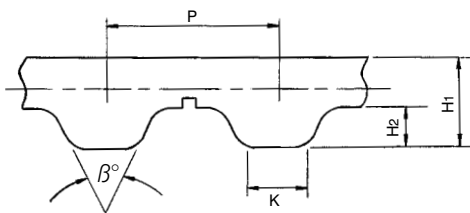

Belt Type	Pitch p	H ₁	H ₂	K	B°
T5	5.00	2.20	1.20	1.80	40
T10	10.00	4.50	2.50	3.50	40
AT5	5.00	2.70	1.20	2.50	50
AT10	10.00	5.00	2.50	5.00	50
AT20	20.00	8.00	5.00	10.00	50
XL	5.08	2.25	1.25	1.35	50
L	9.53	3.50	1.90	3.20	40
H	12.70	4.30	2.30	4.40	40

Standard Widths Metric Belts - width in mm

Belt Type	6	10	16	25	32	50	75	100	150	200
T5	•	•	•	•	•	•				
T10			•	•	•	•	•	•		
AT5	•	•	•	•	•	•	•			
AT10			•	•	•	•	•	•	•	
AT20				•	•	•	•	•	•	•

Standard Widths Imperial Belts - width in 0.01"

Belt Type	025	031	037	050	075	100	150	200
XL	•	•	•	•	•	•		
L			•	•	•	•	•	
H				•	•	•	•	•

Special Belt Backings

To assist in the movement of many products there is a range of specialist materials which can be bonded to the back of all sizes of Polyurethane Belts. Thickness up to 15mm enable profiling of the backing to transport special shapes, such as drawing tube from extrusion process.

Materials available with coefficient of friction varying for 0.3 μ to 1.3 μ and hardness 70° ShA down below 35° ShA, including open cellular materials which accommodate profile changes.

Materials include polyurethane in various grades and hardness values, Linatex, Neoprene for haul - off applications, PVC, Natural Rubbers and Silicon Rubber in flat finish on honeycomb construction for higher grip.

Materials, profiles and constructions are available to cater for almost every application.

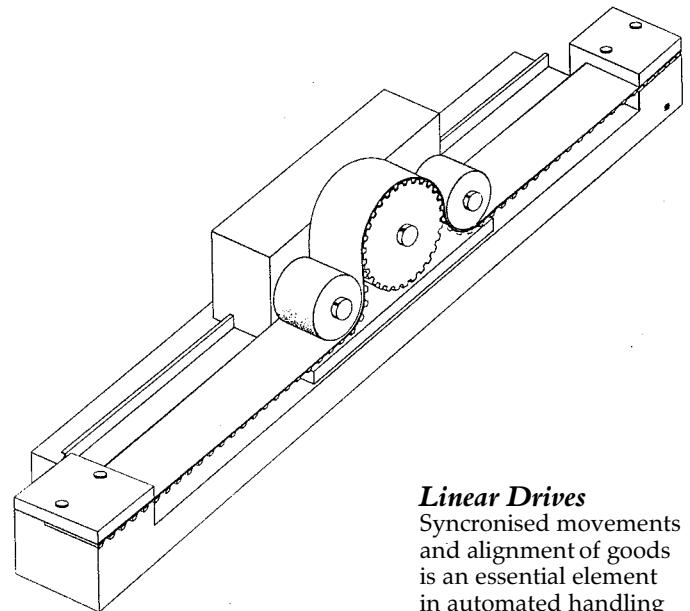

Linear Drives

Synchronised movements and alignment of goods is an essential element in automated handling systems.

Conveyor Systems

For conveyor applications the belts can be used in standard welded endless form to transport items in a horizontal plane, or for inclined applications or where positioning is required a wide range of polyurethane profiles is available for permanent welding to the timing belt back surface. Profiles can also be developed for specific applications. Flighted belts ensure positive movement of products with accurate location providing an option to attachment Roller Chain.

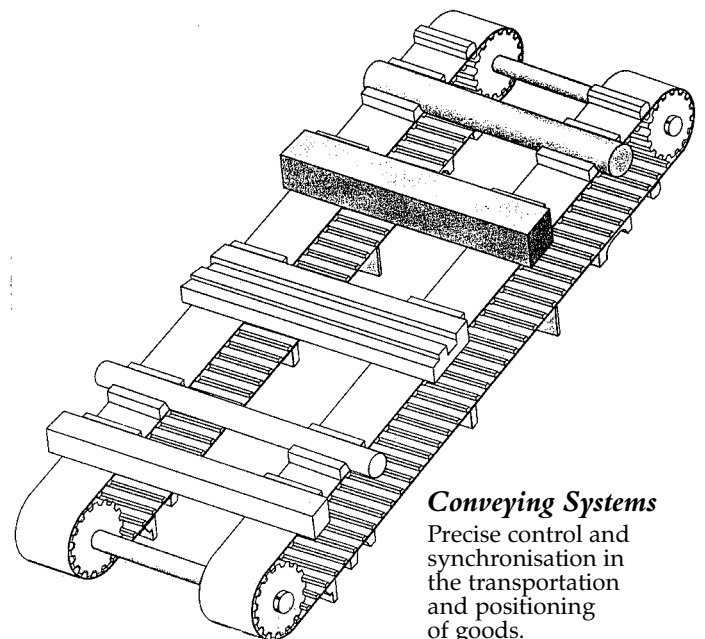

Conveying Systems

Precise control and synchronisation in the transportation and positioning of goods.

Consult Cross and Morse for the best solution to your conveying application

Tel +44 121 360 0155

Fax +44 121 325 1079

Email sales@crossmorse.com